

چراغ‌های خطی با طول ثابت (۱۲۰ سانتی متر)

مشخصات فنی





4800Lm	شار نوری
60 watt	توان‌های نامی
86 Lm/w	راندمان نوری چراغ
CRI>85	شاخص نمود رنگ (CRI)
≤ 3SDCM	SDCM
Nichia LED Chips	نوع منبع نور
Isolated Flicker-free	نوع درایور
220 VAC	مشخصات ولتاژ ورودی
350mA per Driver, PF>0.95	جریان ورودی
THD ≤ 10%	ضریب اعوجاج هارمونیک
Polycarbonate Anti UV Diffuser	نوع اپتیک
120cm	طول پروفیل
4cm, 6cm	عرض پروفیل
توکار، روکار، آویز	نوع نصب
آویز تلسکوپي، کابل آویز فولادی (صفحه ۱۱۵)	لوازم جانبی

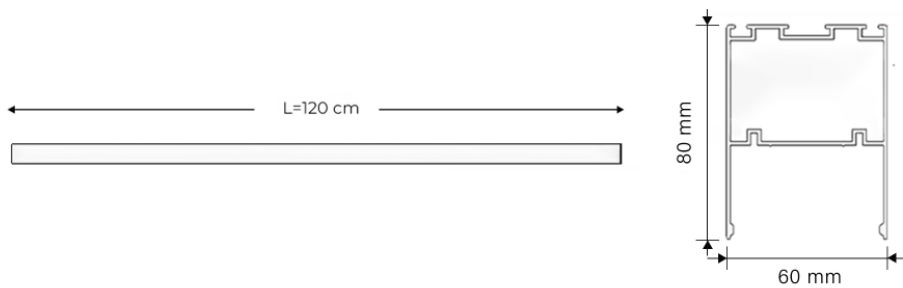



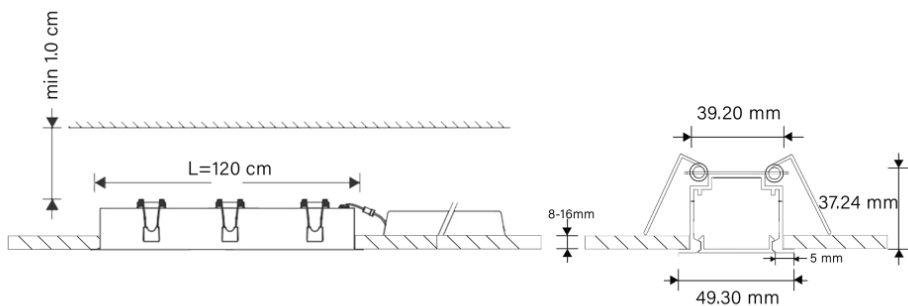







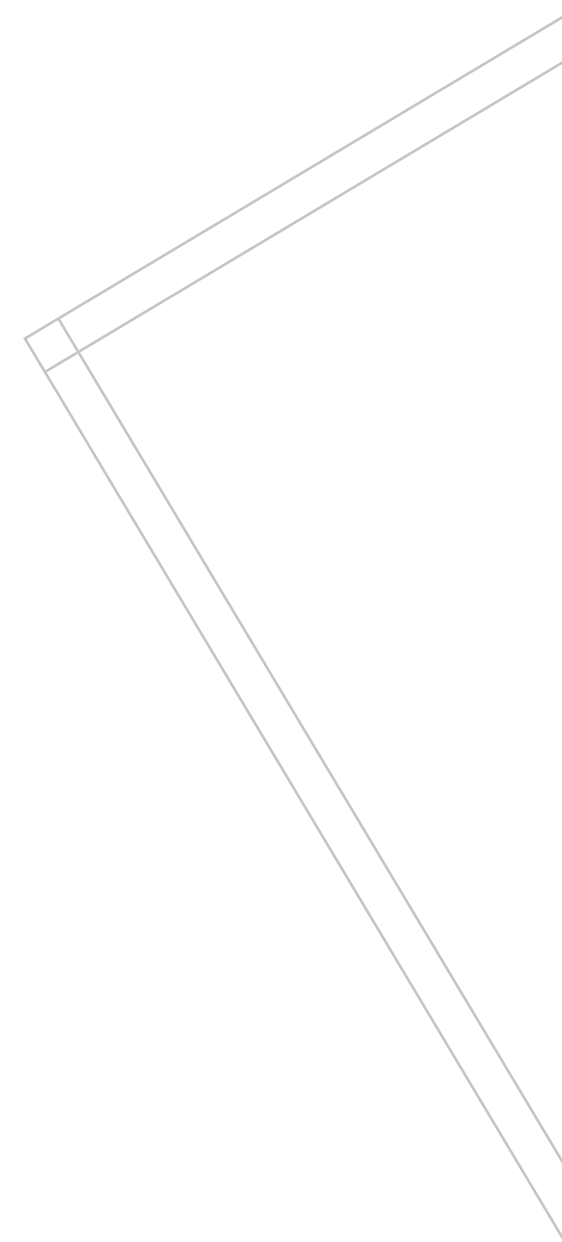

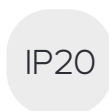

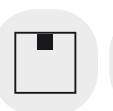
روکار و آویز

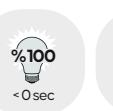

 45mm X 120mm

توکار

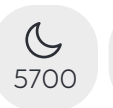

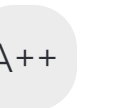
 IP20	 >85 CRI	 120°		 FREE Mercury	 %100 <0 sec	 ON OFF >>15000	
 color PRODUCT	 3000	 4000	 5700			 A++	